

# Power MOSFET

## 130 mAmps, 50 Volts

### P-Channel SOT-323

These miniature surface mount MOSFETs reduce power loss conserve energy, making this device ideal for use in small power management circuitry. Typical applications are dc-dc converters, load switching, power management in portable and battery-powered products such as computers, printers, cellular and cordless telephones.

- Energy Efficient
- Miniature SOT-323 Surface Mount Package Saves Board Space
- Pb-Free Package is available.

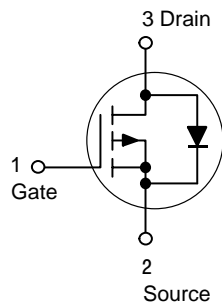

#### THERMAL CHARACTERISTICS

Characteristic	Symbol	Max	Unit
Total Device Dissipation FR-5 Board (Note 3.) $T_A = 25^\circ\text{C}$ Derate above $25^\circ\text{C}$	$P_D$	225 1.8	mW mW/ $^\circ\text{C}$
Thermal Resistance, Junction to Ambient	$R_{\theta JA}$	556	$^\circ\text{C}/\text{W}$
Total Device Dissipation Alumina Substrate, (Note 4.) $T_A = 25^\circ\text{C}$ Derate above $25^\circ\text{C}$	$P_D$	300 2.4	mW mW/ $^\circ\text{C}$
Thermal Resistance, Junction to Ambient	$R_{\theta JA}$	417	$^\circ\text{C}/\text{W}$
Junction and Storage Temperature	$T_J, T_{stg}$	-55 to +150	$^\circ\text{C}$

#### MAXIMUM RATINGS ( $T_J = 25^\circ\text{C}$ unless otherwise noted)

Rating	Symbol	Value	Unit
Drain-to-Source Voltage	$V_{DSS}$	50	$V_{dc}$
Gate-to-Source Voltage – Continuous	$V_{GS}$	$\pm 20$	$V_{dc}$
Drain Current			mA
– Continuous @ $T_A = 25^\circ\text{C}$	$I_D$	130	
– Pulsed Drain Current ( $t_p \leq 10 \mu\text{s}$ )	$I_{DM}$	520	
Total Power Dissipation @ $T_A = 25^\circ\text{C}$	$P_D$	225	mW
Operating and Storage Temperature Range	$T_J, T_{stg}$	- 55 to 150	$^\circ\text{C}$
Thermal Resistance – Junction-to-Ambient	$R_{\theta JA}$	556	$^\circ\text{C}/\text{W}$
Maximum Lead Temperature for Soldering Purposes, for 10 seconds	$T_L$	260	$^\circ\text{C}$

## LBSS84WT1G

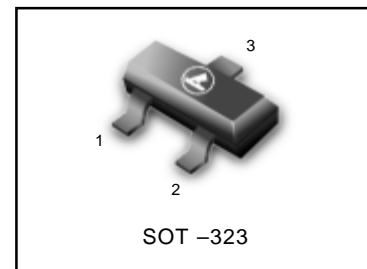

#### Marking Diagram

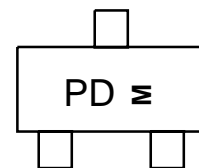

PD = Device Code  
M = Month Code

#### ORDERING INFORMATION

Device	Package	Shipping
LBSS84WT1G	SOT-323	3000/Tape&Reel
LBSS84WT1G	SOT-323	10000/Tape&Reel

# LBSS84WT1G

## ELECTRICAL CHARACTERISTICS (T<sub>A</sub> = 25°C unless otherwise noted)

Characteristic	Symbol	Min	Typ	Max	Unit
----------------	--------	-----	-----	-----	------

### OFF CHARACTERISTICS

Drain-to-Source Breakdown Voltage (V <sub>GS</sub> = 0 Vdc, I <sub>D</sub> = 250 μAdc)	V <sub>(BR)DSS</sub>	50	–	–	Vdc
Zero Gate Voltage Drain Current (V <sub>DS</sub> = 25 Vdc, V <sub>GS</sub> = 0 Vdc) (V <sub>DS</sub> = 50 Vdc, V <sub>GS</sub> = 0 Vdc) (V <sub>DS</sub> = 50 Vdc, V <sub>GS</sub> = 0 Vdc, T <sub>J</sub> = 125°C)	I <sub>DSS</sub>	–	–	0.1 15 60	μAdc
Gate-Body Leakage Current (V <sub>GS</sub> = ± 20 Vdc, V <sub>DS</sub> = 0 Vdc)	I <sub>GSS</sub>	–	–	±10	nAdc

### ON CHARACTERISTICS (Note 1.)

Gate-Source Threshold Voltage (V <sub>DS</sub> = V <sub>GS</sub> , I <sub>D</sub> = 1.0 mAdc)	V <sub>GS(th)</sub>	0.8	–	2.0	Vdc
Static Drain-to-Source On-Resistance (V <sub>GS</sub> = 5.0 Vdc, I <sub>D</sub> = 100 mAdc)	r <sub>DS(on)</sub>	–	5.0	10	Ohms
Transfer Admittance (V <sub>DS</sub> = 25 Vdc, I <sub>D</sub> = 100 mAdc, f = 1.0 kHz)	y <sub>fs</sub>	50	–	–	mS

### DYNAMIC CHARACTERISTICS

Input Capacitance	(V <sub>DS</sub> = 5.0 Vdc)	C <sub>iss</sub>	–	30	–	pF
Output Capacitance	(V <sub>DS</sub> = 5.0 Vdc)	C <sub>OSS</sub>	–	10	–	
Transfer Capacitance	(V <sub>DG</sub> = 5.0 Vdc)	C <sub>rss</sub>	–	5.0	–	

### SWITCHING CHARACTERISTICS (Note 2.)

Turn-On Delay Time	(V <sub>DD</sub> = -15 Vdc, I <sub>D</sub> = -2.5 Adc, R <sub>L</sub> = 50 Ω)	t <sub>d(on)</sub>	–	2.5	–	ns
Rise Time		t <sub>r</sub>	–	1.0	–	
Turn-Off Delay Time		t <sub>d(off)</sub>	–	16	–	
Fall Time		t <sub>f</sub>	–	8.0	–	
Gate Charge		Q <sub>T</sub>	–	6000	–	pC

### SOURCE-DRAIN DIODE CHARACTERISTICS

Continuous Current	I <sub>S</sub>	–	–	0.130	A
Pulsed Current	I <sub>SM</sub>	–	–	0.520	
Forward Voltage (Note 2.)	V <sub>SD</sub>	–	2.5	–	V

1. Pulse Test: Pulse Width ≤ 300 μs, Duty Cycle ≤ 2%.
2. Switching characteristics are independent of operating junction temperature.

## TYPICAL ELECTRICAL CHARACTERISTICS

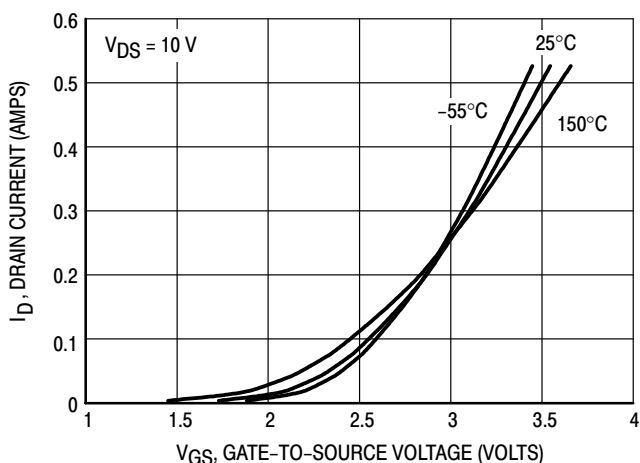

Figure 1. Transfer Characteristics

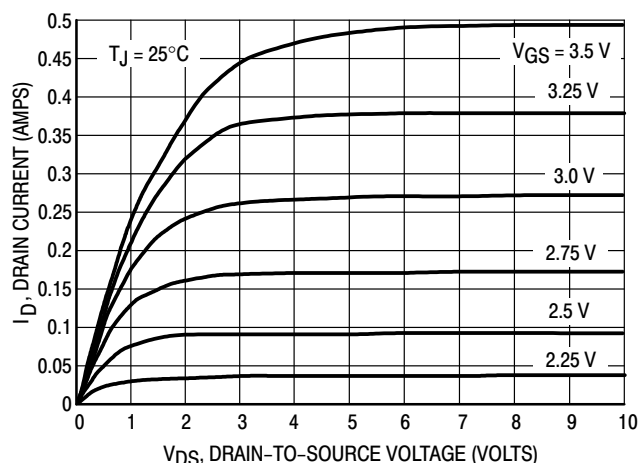

Figure 2. On-Region Characteristics

# LBSS84WT1G

## TYPICAL ELECTRICAL CHARACTERISTICS

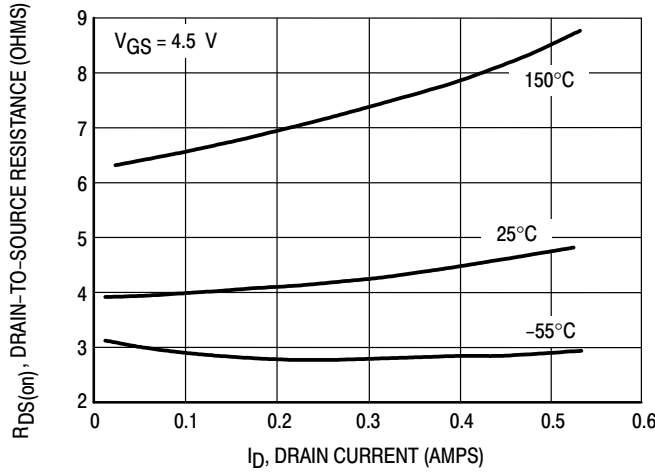

Figure 3. On-Resistance versus Drain Current

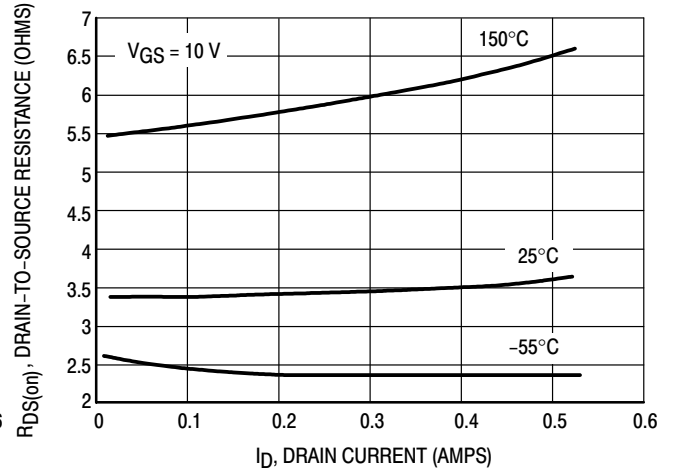

Figure 4. On-Resistance versus Drain Current

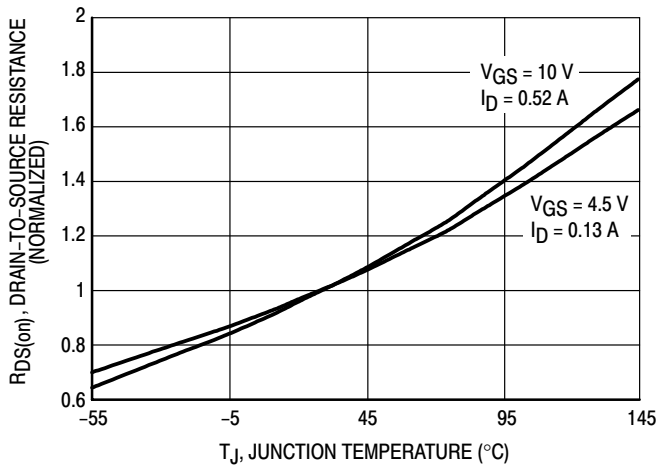

Figure 5. On-Resistance Variation with Temperature

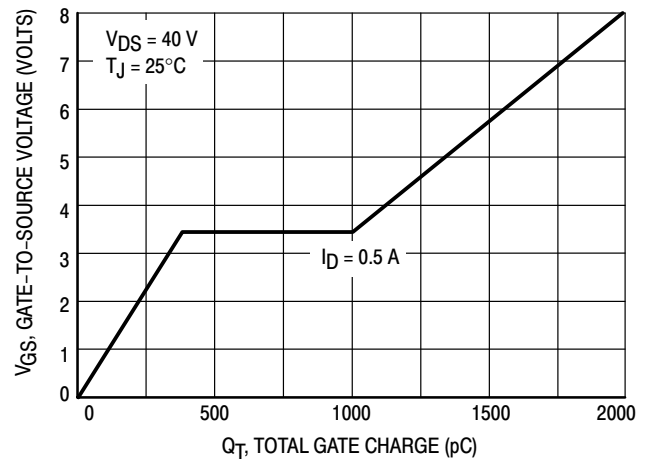

Figure 6. Gate Charge

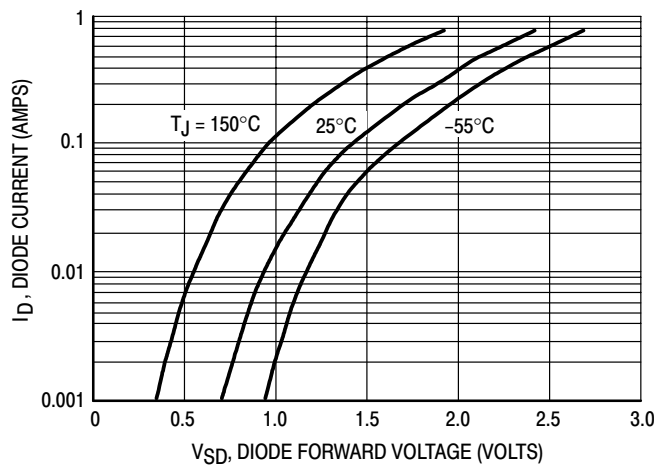
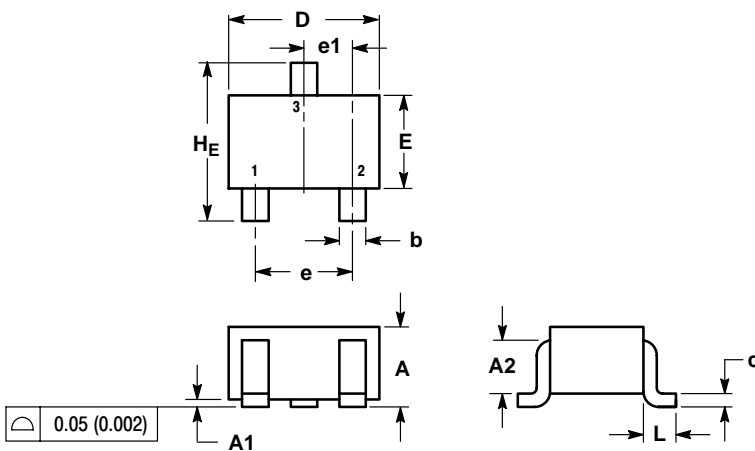

Figure 7. Body Diode Forward Voltage

# LBSS84WT1G

## SC-70 (SOT-323)



NOTES:

1. DIMENSIONING AND TOLERANCING PER ANSI Y14.5M, 1982.
2. CONTROLLING DIMENSION: INCH.

DIM	MILLIMETERS			INCHES		
	MIN	NOM	MAX	MIN	NOM	MAX
A	0.80	0.90	1.00	0.032	0.035	0.040
A1	0.00	0.05	0.10	0.000	0.002	0.004
A2	0.7 REF			0.028 REF		
b	0.30	0.35	0.40	0.012	0.014	0.016
c	0.10	0.18	0.25	0.004	0.007	0.010
D	1.80	2.10	2.20	0.071	0.083	0.087
E	1.15	1.24	1.35	0.045	0.049	0.053
e	1.20	1.30	1.40	0.047	0.051	0.055
e1	0.65 BSC			0.026 BSC		
L	0.425 REF			0.017 REF		
HE	2.00	2.10	2.40	0.079	0.083	0.095

### GENERIC MARKING DIAGRAM

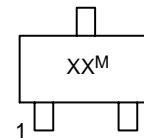

- XX = Specific Device Code
- M = Date Code
- = Pb-Free Package

\*This information is generic. Please refer to device data sheet for actual part marking. Pb-Free indicator, "G" or microdot "▪", may or may not be present.

### SOLDERING FOOTPRINT\*

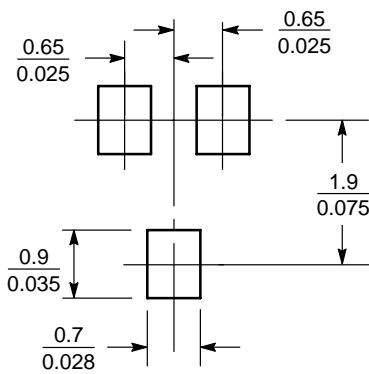

SCALE 10:1 (mm / inches)

## EMBOSSED TAPE AND REEL DATA FOR DISCRETES

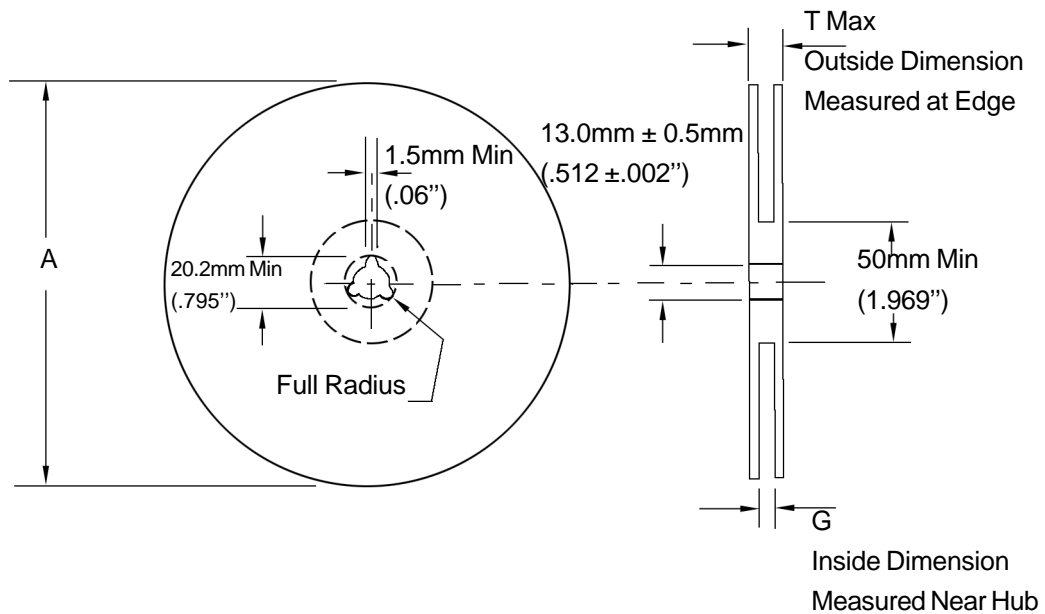

Size	A Max	G	T Max
8 mm	330mm (12.992")	8.4mm+1.5mm, -0.0 (.33"+.059", -0.00)	14.4mm (.56")
12mm	330mm (12.992")	12.4mm+2.0mm, -0.0 (.49 "+ .079", -0.00)	18.4mm (.72")
16mm	360mm (14.173")	16.4mm+2.0mm, -0.0 (.646"+.078", -0.00)	22.4mm (.882")
24 mm	360mm (14.173")	24.4mm+2.0mm, -0.0 (.961"+.070", -0.00)	30.4mm (1.197")

### Reel Dimensions

Metric Dimensions Govern — English are in parentheses for reference only

#### Storage Conditions

Temperature: 5 to 40 Deg.C (20 to 30 Deg. C is preferred)

Humidity: 30 to 80 RH (40 to 60 is preferred )

Recommended Period: One year after manufacturing

(This recommended period is for the soldering condition only. The characteristics and reliabilities of the products are not restricted to this limitation)

## Shipment Specification

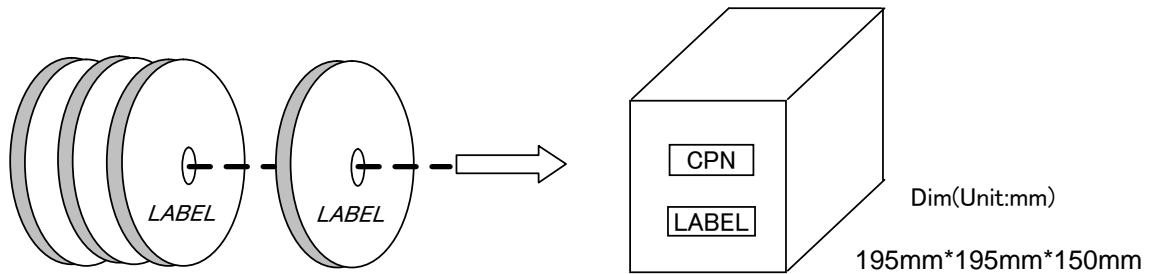

10 Reel

3000PCS/Reel  
8000PCS/Reel (SOT-723,SOD-723)

10Reel/Inner Box  
30KPCS/Inner Box  
80KPCS/Inner Box (SOT-723,SOD-723)

Dim(Unit:mm)  
460mm\*400mm\*420mm

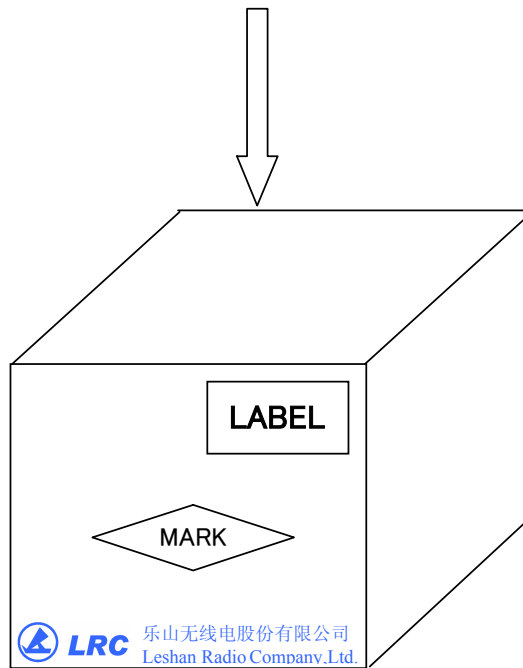

12 Inner Box/Carton

360KPCS/Carton  
960KPCS/Carton (SOT-723,SOD-723)